



# H-1216 Ariel Collection

Job Name:
Type:
Quantity:

## HI-LITE MFG. CO., INC

13450 Monte Vista Avenue  
Chino, California 91710  
Telephone: (909) 465-1999  
Toll Free: (800) 465-0211  
Fax: (909) 465-0907  
web: www.hilitemfg.com  
e-mail: sales@hilitemfg.com

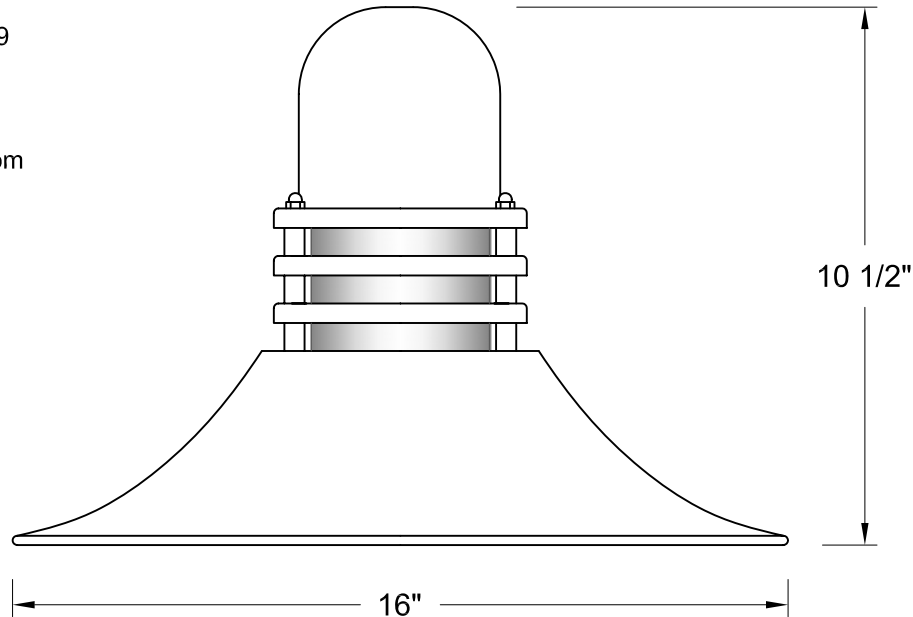

**FINISH** -Offered in exceptional finishes, comprised of: polyester/polished powder coat, baking enamel liquid, raw metal, or galvanized finishes.

Standard Finishes are: 91(Black), 93(White), 95(Dark Green), 96(Galvanized), BR47(Powder Coat Rust), BK01(Black Texture), GN20(Powder Coat Patina).

Upgraded Finishes are: 29, 66, 82, 90, 92, 94, 97, 99, 100, 103, 104, 105, 110, 112, 113, 114, 115, 117, 118, 119, 120, 127, 128, 129, 133, 134, 135, 136, 98, 101, 102, 137, 138, 139, 140, 121, 122, 123, 124, 125, 126, 11, 01, 22, 25, 33, 77, 89, 24, 44, 48, 49, 15, 16.

For interior finish of fixture refer to color chart on pages 344-348.

**MOUNTING** - Cord, Stem, Arm, and Flush mounting available.

**ACCESSORIES** - SK(Swivel Knuckle), FX(Flexible Tubing for cord mounted fixture only), CAL(Clear Acrylic Layer), BAL(Blue Acrylic Layer), RAL(Red Acrylic Layer) and GNAL(Green Acrylic Layer) available.

**REFLECTOR** - Heavy duty, spun shade, aluminum 6061-0 and/or 1100-0, galvanized 22 gauge, steel 20/22 gauge, copper 032/040 and brass 032/040 construction. Dependant on finish.

### SOCKETS/LAMPS - Available in:

Incandescent

- rated 100 watt max/120 volt, medium base.

Compact Fluorescent(CFL)

- rated 13/18/26/32 watt max/120/277 volt, GX24Q base.

Metal Halide(MH)

- rated 35/50/70/100 watt max/120/208/240/277 volt, medium base, 4KV socket.

High Pressure Sodium(HPS)

- rated 50/70/100 watt max/120/277 volt, medium base.

Light-Emitted Diode(LED)

-See LED specification sheet.

**LENS OPTION** - CLR(Clear), RIB(Clear Ribbed), FR(Frost), RD(Red), BL(Blue), GRN(Green), AM(Amber) and AMC(Amber Crackle) available.

MADE IN THE U.S.A.

Suitable for wet location.  
(Except when cord mounted)

